

ART. 16

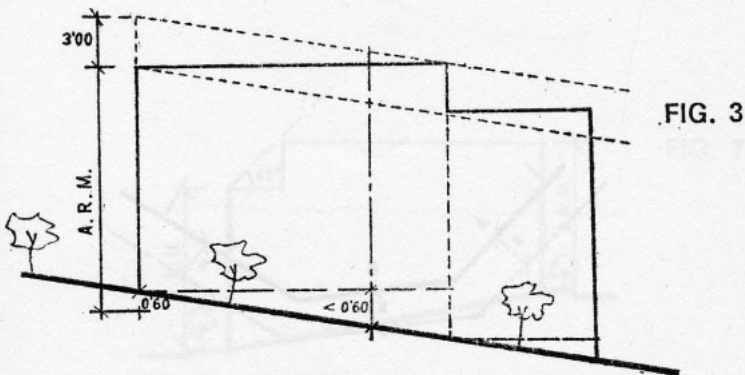

A. R. M. = ALTURA REGULADORA MAXIMA

ART. 17

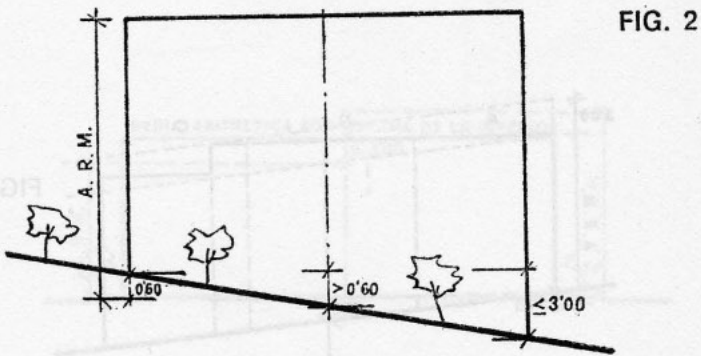
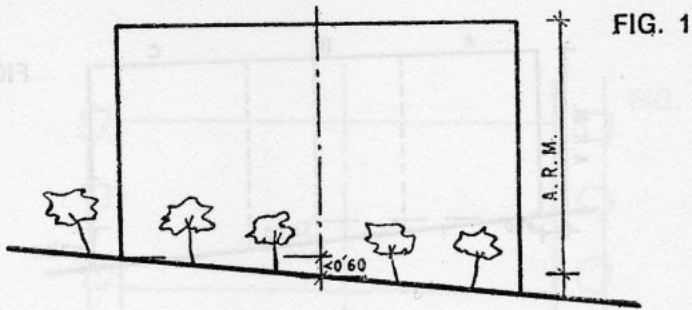
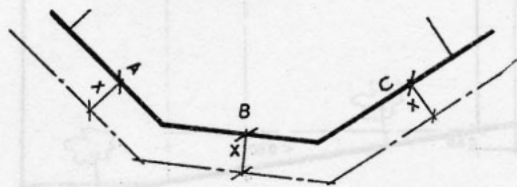
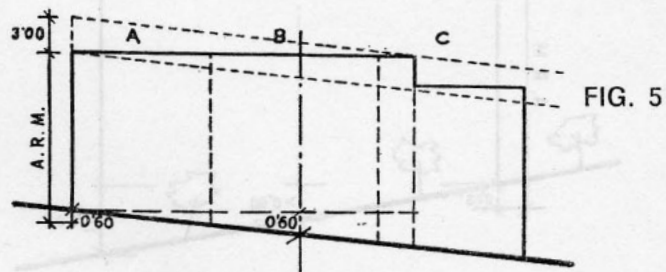
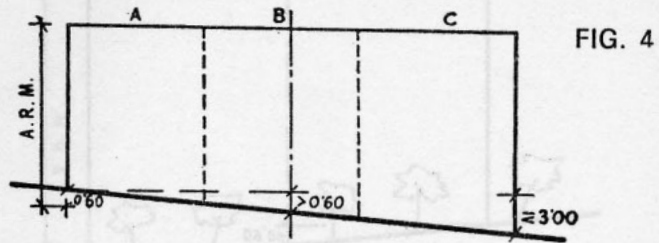

ART. 18

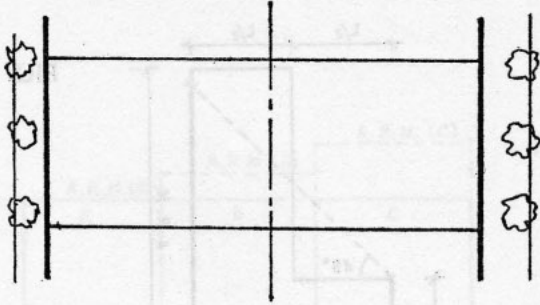

FIG. 6

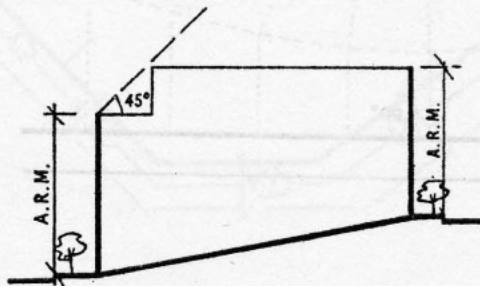
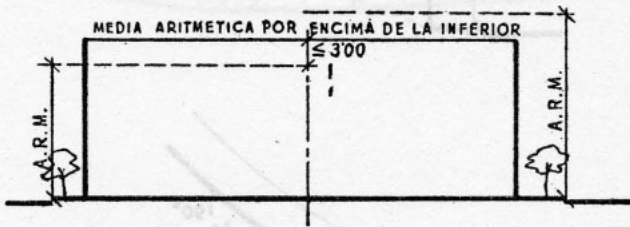

FIG. 7

A. R. M. = ALTURA REGULADORA MAXIMA

ART. 18

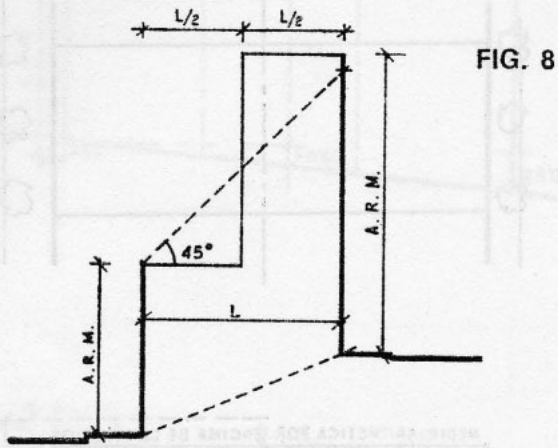
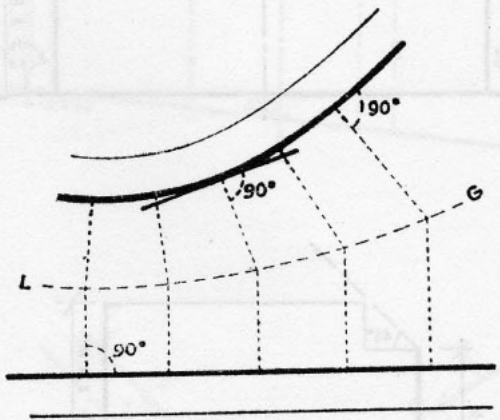

FIG. 8



L. G. = LUGAR GEOMETRICO DE LOS PUNTOS
EQUIDISTANTES DE LAS FACHADAS

A. R. M. = ALTURA REGULADORA MAXIMA

ART. 19

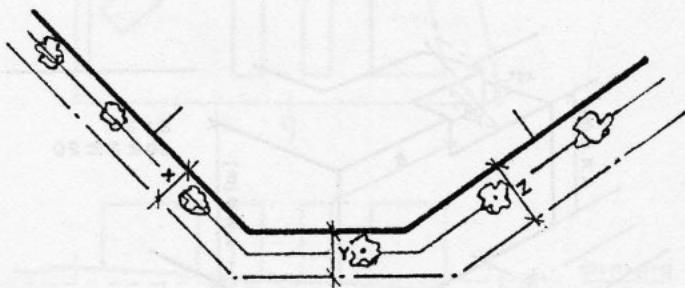
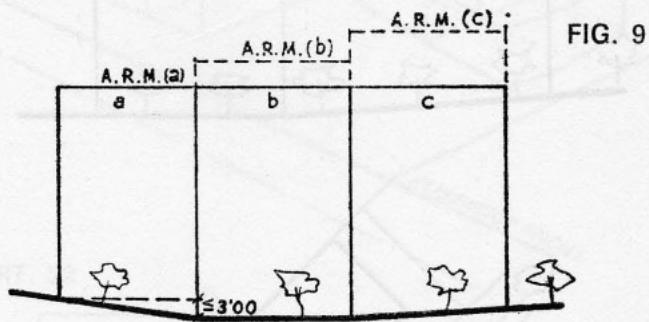

A. R. M. = ALTURA REGULADORA MAXIMA

ART. 19

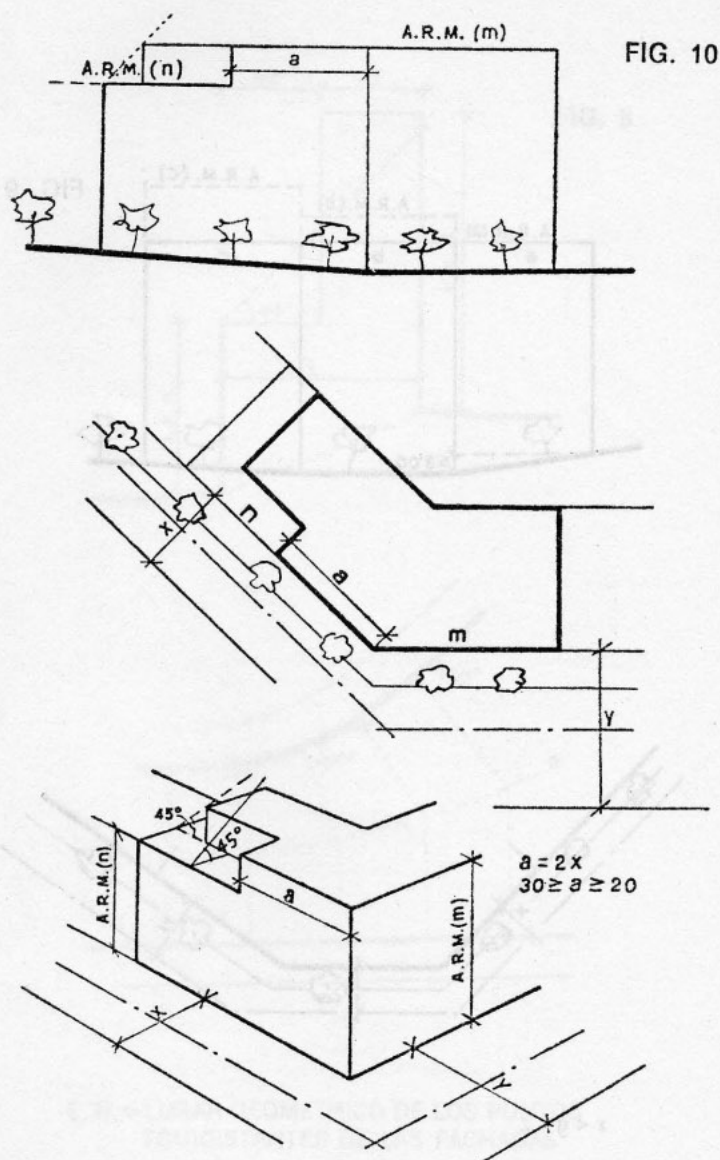
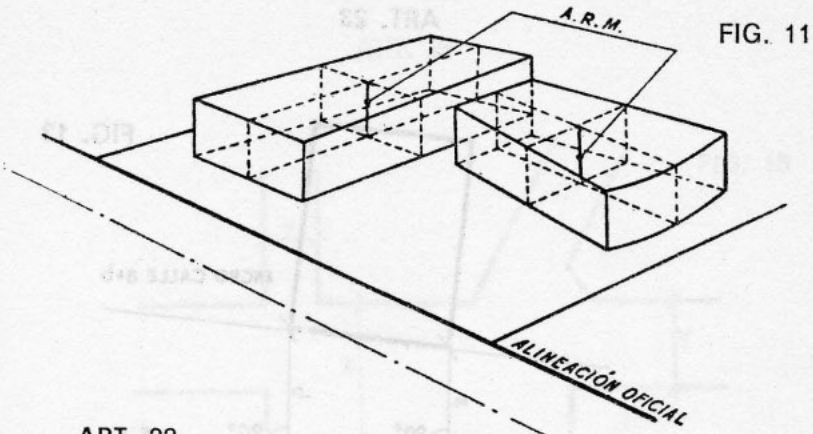

FIG. 10

A. R. M. = ALTURA REGULADORA MAXIMA

ART. 20



ART. 22

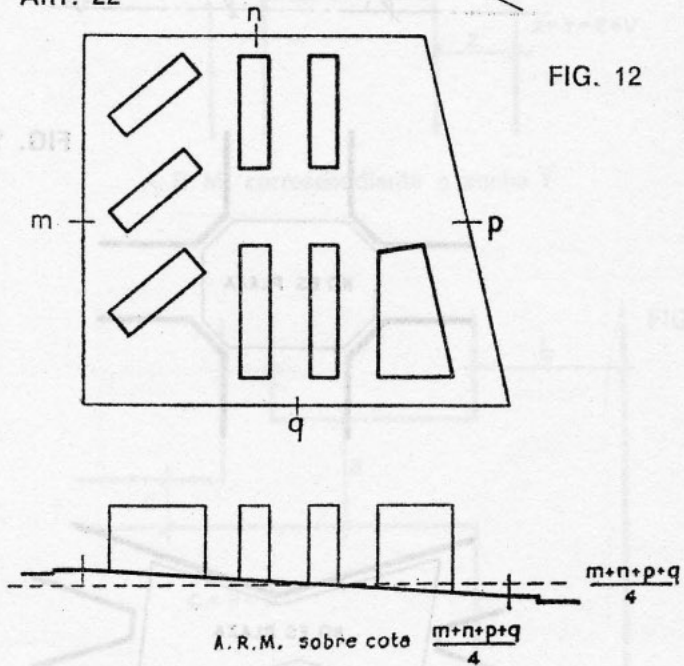

A. R. M. = ALTURA REGULADORA MAXIMA

ART. 23

FIG. 13

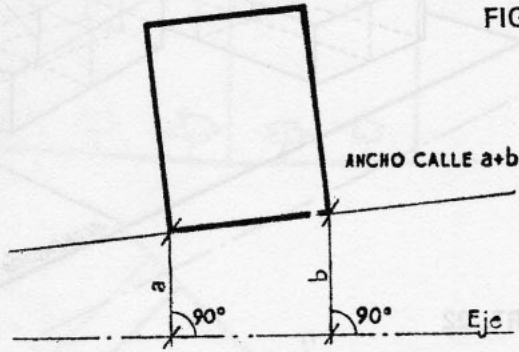
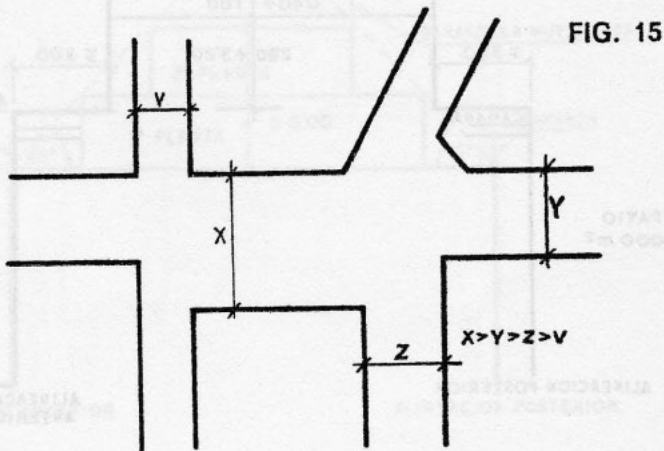

FIG. 14



ART. 24



A. R. M. correspondiente a ancho Y

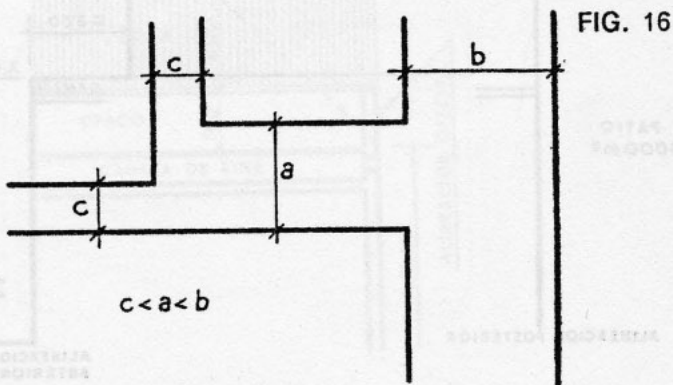

A. R. M. correspondiente a ancho a

ZONAS { 1.2.3.4.5.6.7
14.16.17.19

ART. 25

FIG. 17

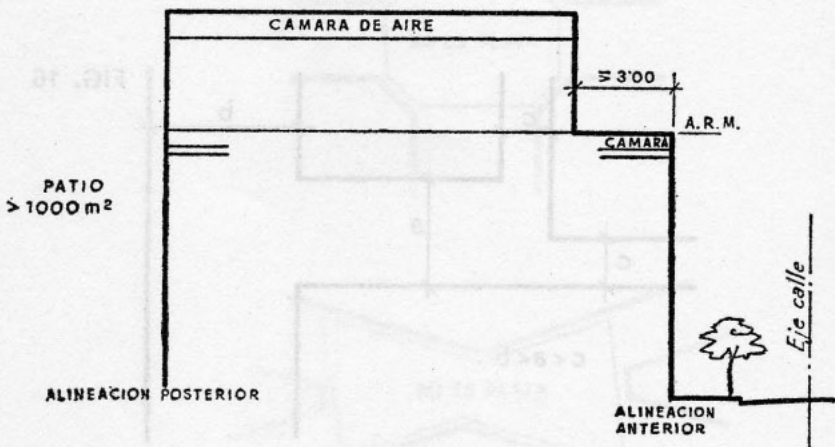
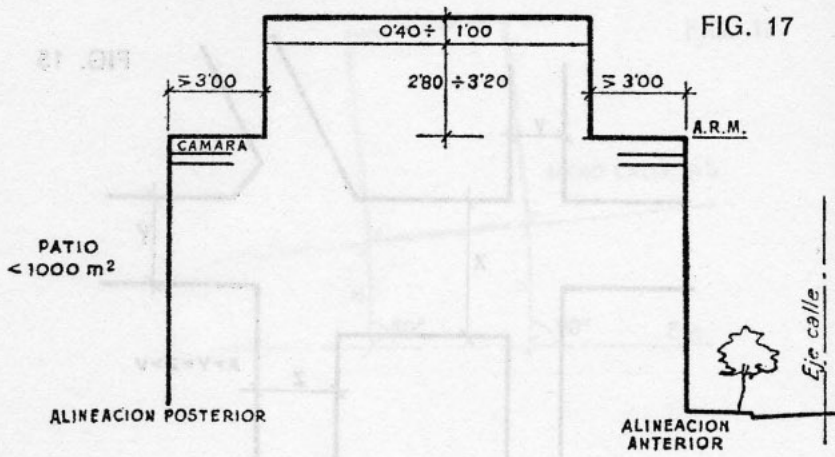

A. R. M. = ALTURA REGULADORA MAXIMA

ART. 25

FIG. 18

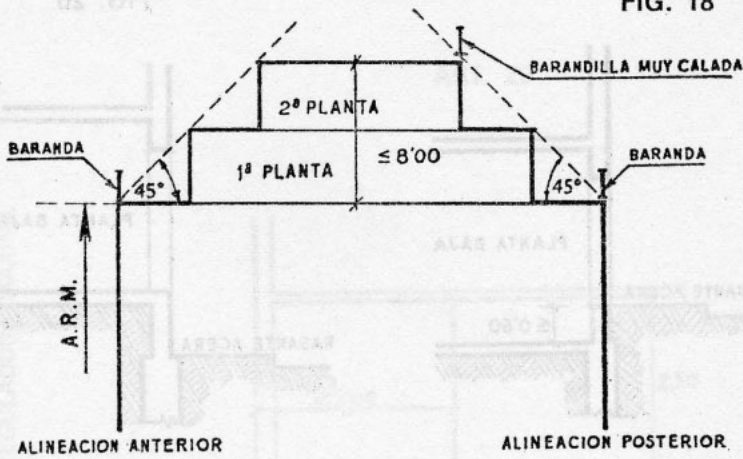
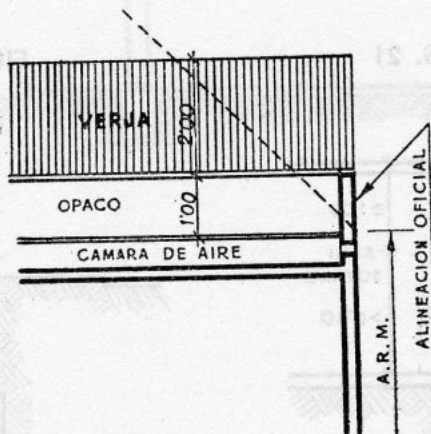

FIG. 19



A. R. M. = ALTURA REGULADORA MAXIMA

ART. 28

FIG. 20

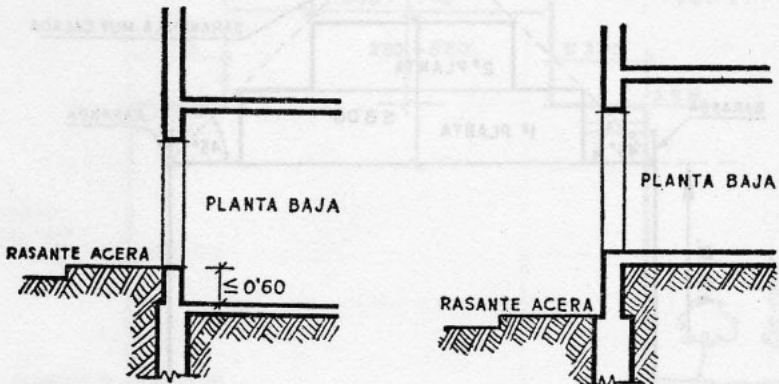

FIG. 21

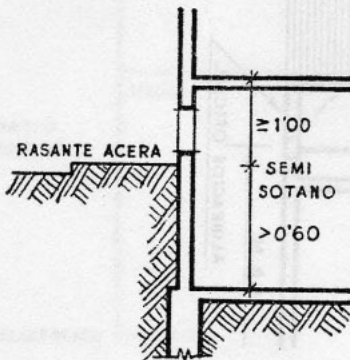
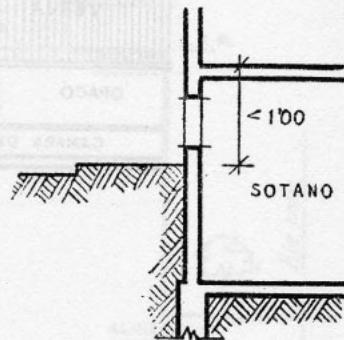

FIG. 22



P. E. = PROFUNDIDAD EDIFICABLE
A. R. M. = ALTURA REGULADORA MAXIMA

ART. 29

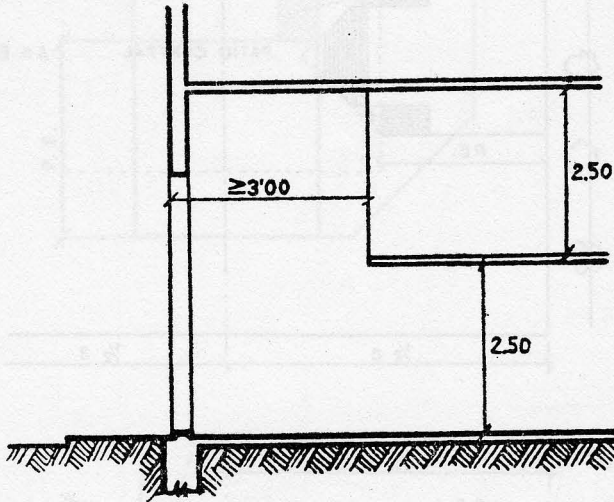
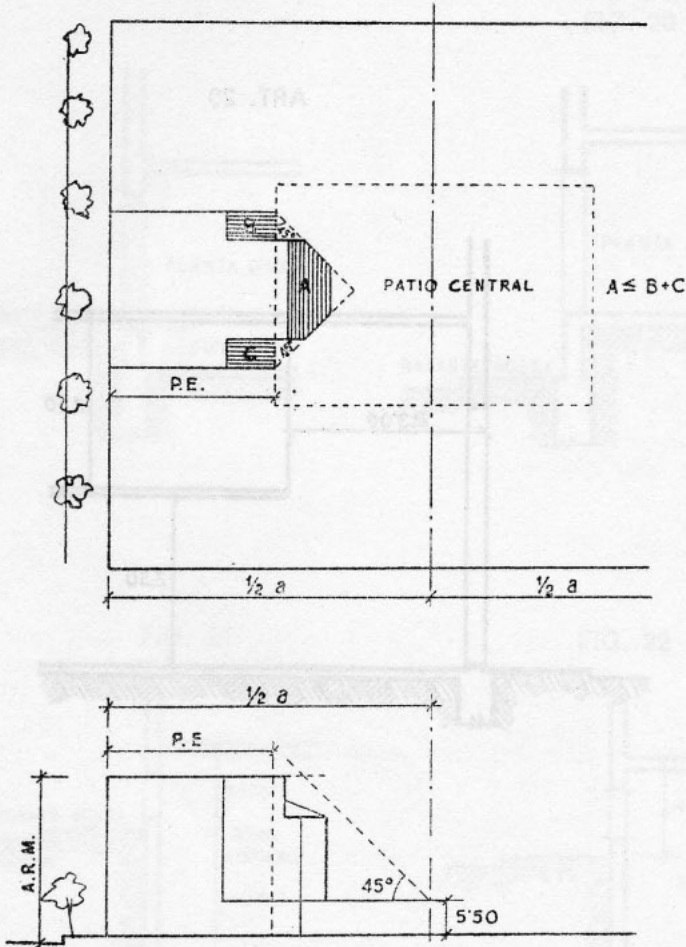

FIG. 23

ART. 36

FIG. 24



P. E. = PROFUNDIDAD EDIFICABLE

A. R. M. = ALTURA REGULADORA MAXIMA

ART. 37

FIG. 25

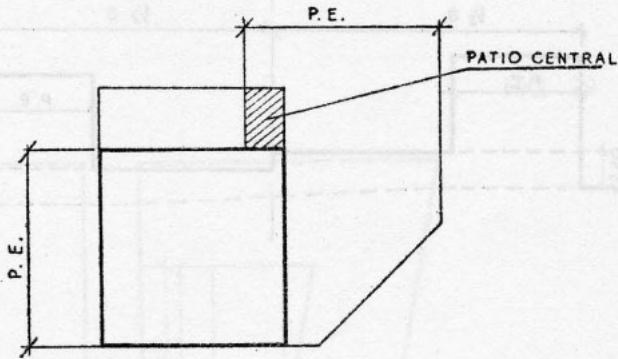

FIG. 26



P. E. = PROFUNDIDAD EDIFICABLE

ART. 39

FIG. 27

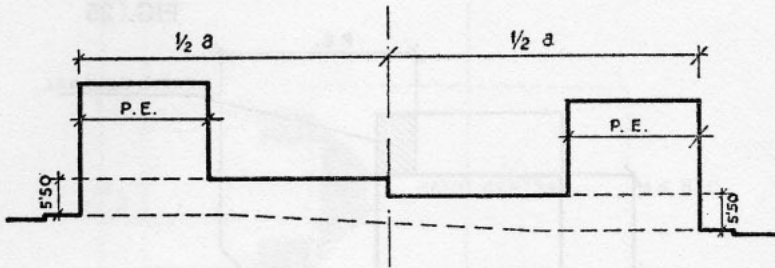

ART. 40

ZONA 14

FIG. 28

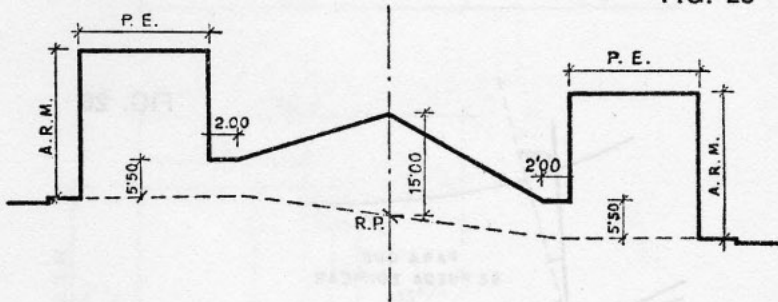

P. E. = PROFUNDIDAD EDIFICABLE

A. R. M. = ALTURA REGULADORA MAXIMA

R. P. = RASANTE PROMEDIO DE LA MANZANA

ART. 41

FIG. 29

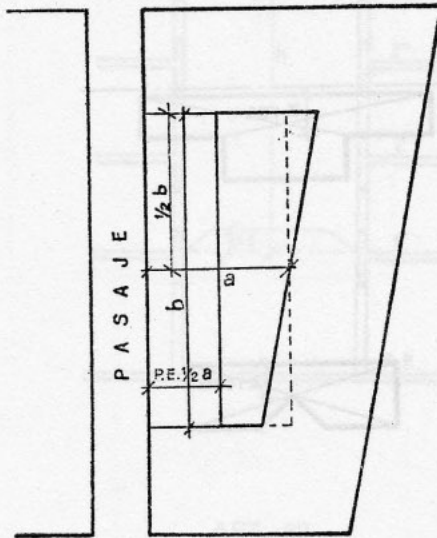

P. E. = PROFUNDIDAD EDIFICABLE

ART. 46

FIG. 30

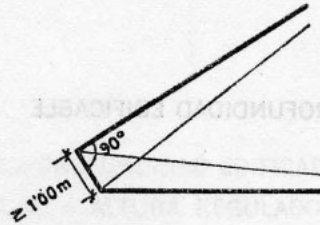
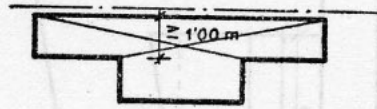
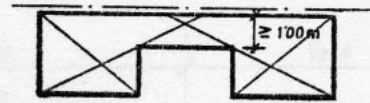

ART. 47

FIG. 31

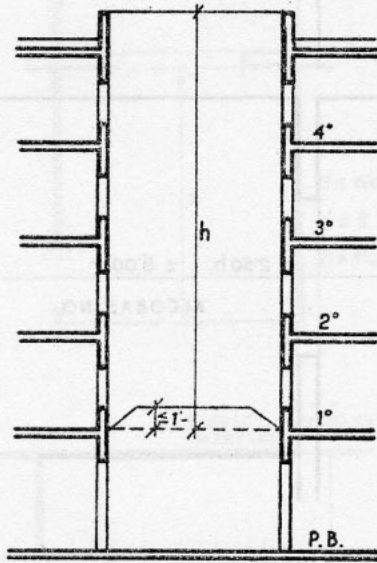

ART. 62

FIG. 32



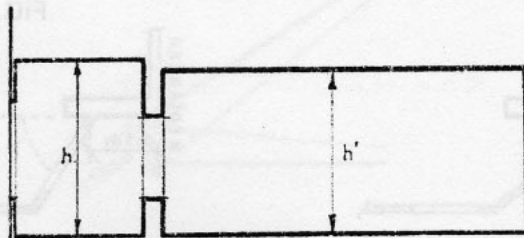
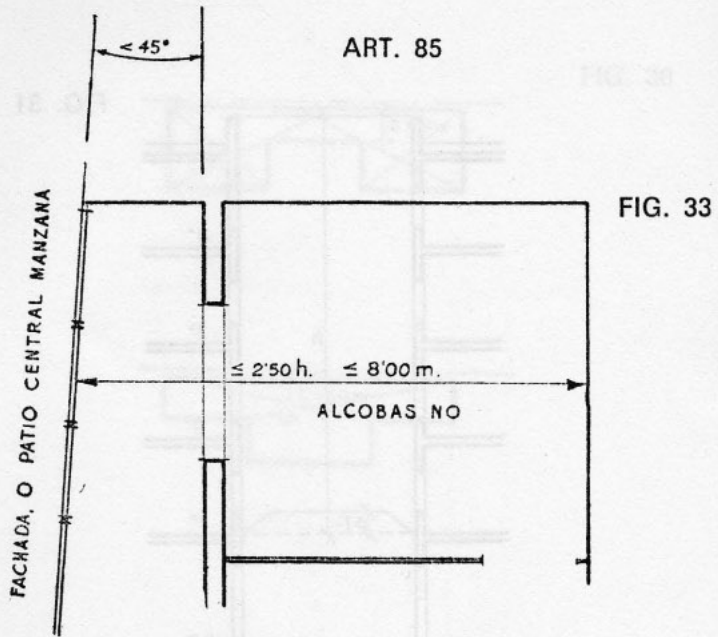

ART. 85

FIG. 34

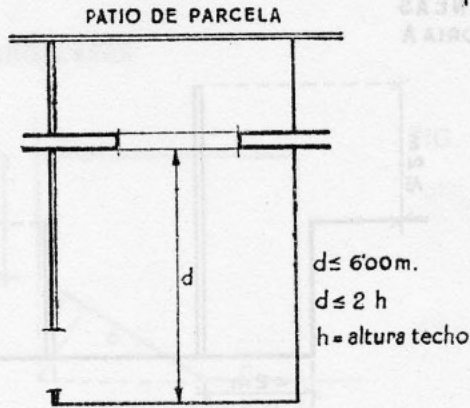
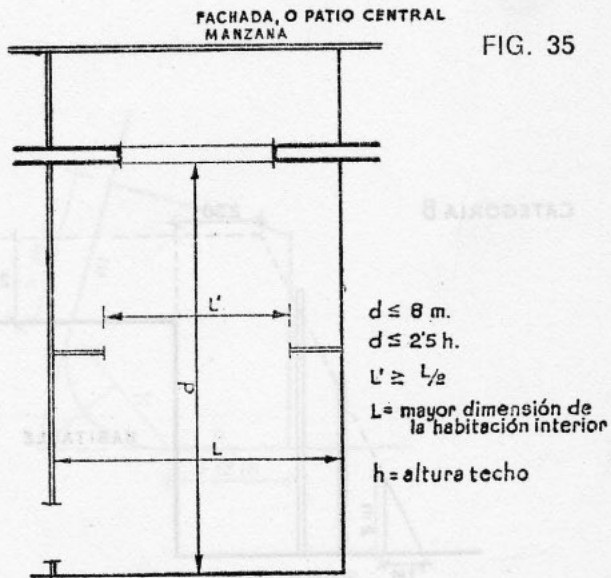

FIG. 35



ART. 94

CHIMENEAS
CATEGORIA A

FIG. 36

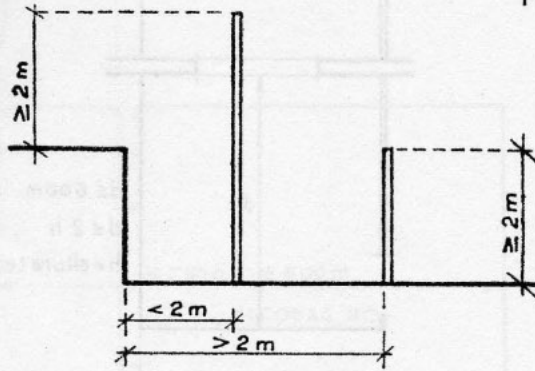

CATEGORIA B

FIG. 37

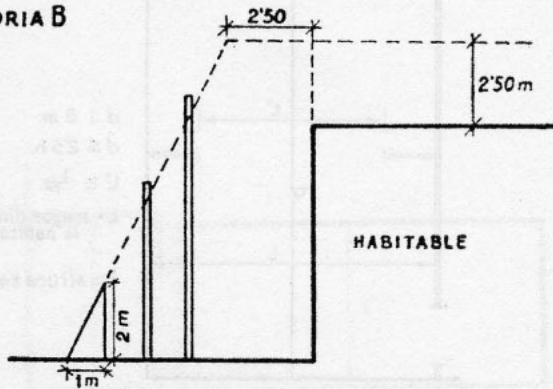



ART. 170

EDIFICIOS SINGULARES

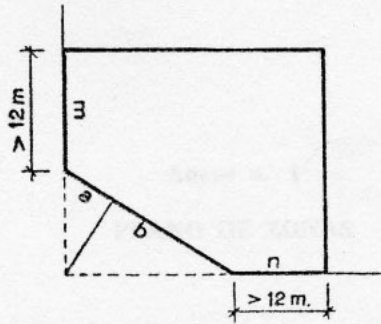
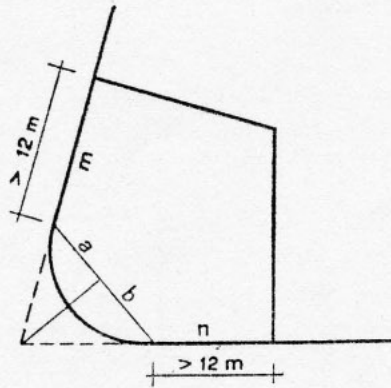

FIG. 38



$$\begin{array}{ll}
 m > 12 \text{ m.} & m+a > 20 \text{ m.} \\
 n > 12 \text{ m.} & n+b > 20 \text{ m.}
 \end{array}$$

